

# PH06

## Phone Holder

### Product Manual

\*Please thoroughly review the product manual before usage. Incorrect installation and improper usage may result in the phone dislodging from the mount, falling, damaging the mount, and consequently voiding any associated complimentary warranty services.

## Product Specifications

Model: PH06

---

Compatible Phone Size (Including Phone Cases)

Width Range: 65-92mm/2.56-3.62in Length Range: 125-169mm/4.92-6.65in Thickness Range: ≤12.5mm/0.49in

---

Input Voltage: 12-16V

---

Wireless Charging Output Power: 15W(MAX)

Wired Charging Output Power: 36W(MAX)

---

Protection Features: Reverse Connection Protection / Short Circuit Protection / Overvoltage Protection /  
Overcurrent Protection / Overcharge Protection / Undervoltage Protection / Over-  
temperature Protection / Foreign Object Detection Protection

---

Vibration Damping Structure: Multiple vibration dampening

---

# Packing List

①

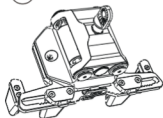

Quantity: 1 piece

Rear View Mirror  
Mobile Phone Holder

②



Quantity: 1 piece

Rear View Mirror  
Mount Assembly

③



Quantity: 1 piece

M6 Anti-  
loosening Nut

④



Quantity: 1 piece

M6×16

⑤



Quantity: 1 piece

M6×22

⑥



Quantity: 1 piece

5mm Hex Wrench

⑦



Quantity: 1 piece

Screw Glue

⑧

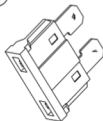

Quantity: 1 piece

Spare Fuse (10A)  
(for wireless  
charging module)

⑨



Quantity: 8 pieces

Cable Ties (for wireless  
charging module)

## Product Diagram

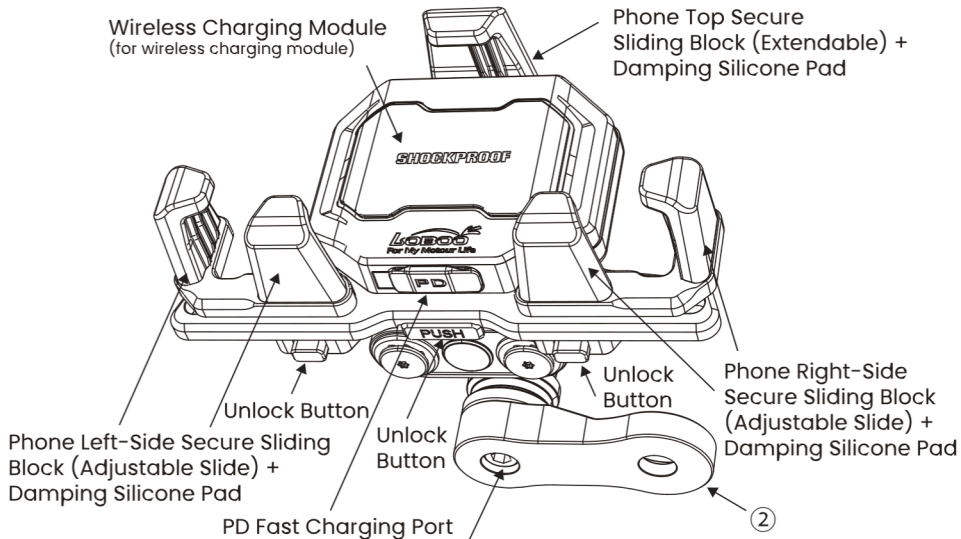

- After adjusting to the proper position, tighten the screws with screwdriver glue and check regularly.

## Product Diagram

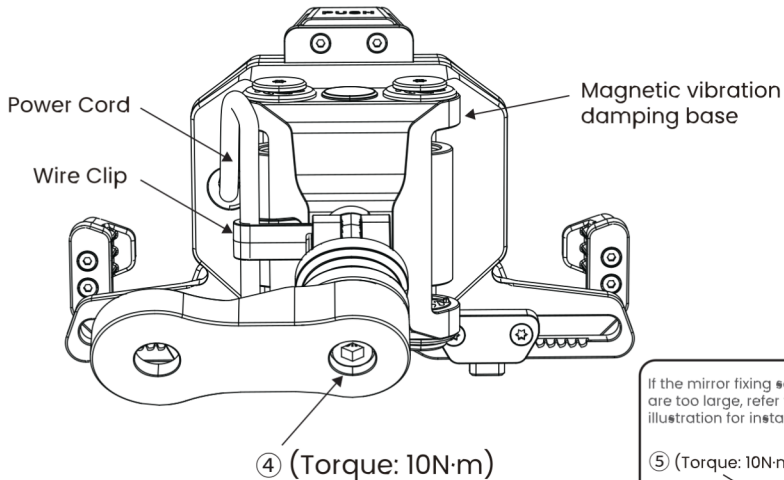

Note: The power cord needs to be clamped into the clip (9-11cm/3.54-4.33in from the outlet to the clip).

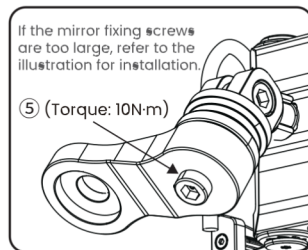

## Wireless Charging Module Wiring Diagram

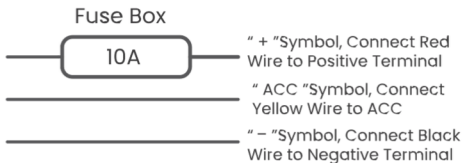

ACC refers to the 12V-15V wire on the motorcycle that powers on (Long-time power-on) when the ignition key is turned on and powers off (Long-time power-off) when the ignition key is turned off.

## Installation and Usage, ACC Detection Video



Scan QR Code to Watch Video

## Installation Diagram

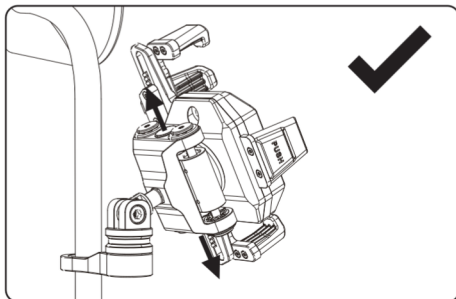
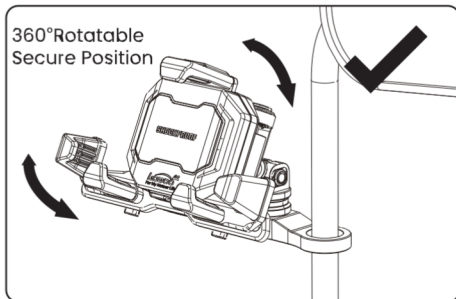

# Installation Diagram

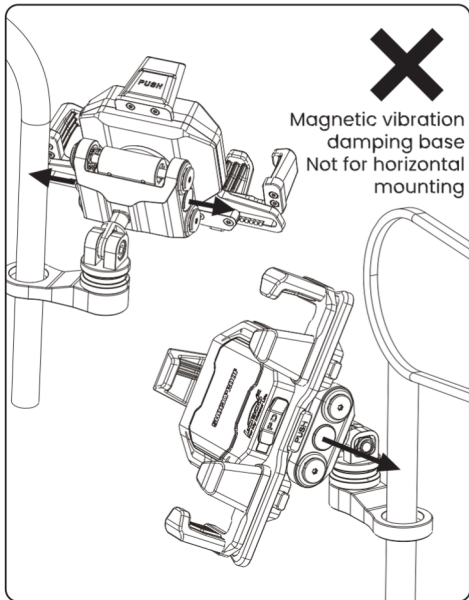
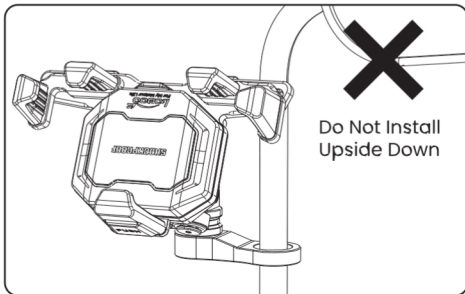
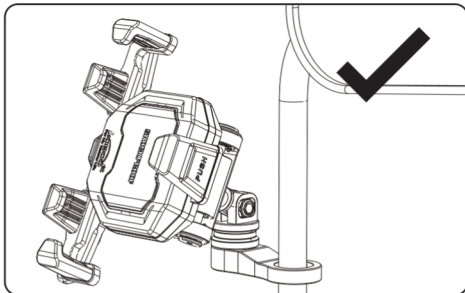

## Usage

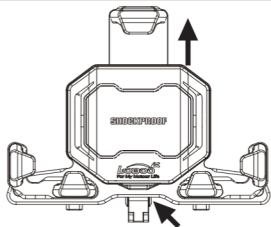

1. Press the center unlock button to pop up the top retaining sliding block.

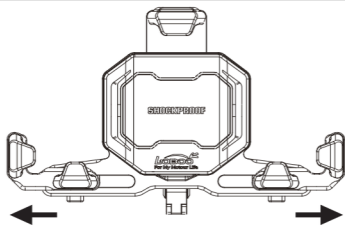

2. Press and hold the left and right fixed sliding block unlock button to adjust the width.

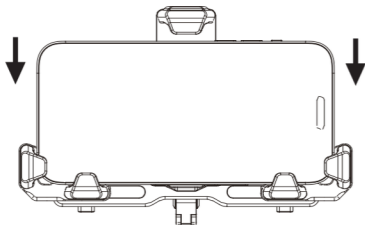

3. Place your phone into the mount.

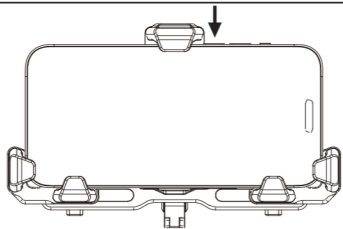

4. Adjust the left and right fixed sliding block to fit the phone, and press down on the top fixed sliding block to clamp the phone.



## Notes

1. This phone holder can be used for long time driving on unpaved roads, if you need to use it for jumping, racing, high intensity off-road, etc., please pay attention to check that the slider is sufficiently clamped .
2. Please adjust the positions of the left and right sliding block correctly. The gap between the left and right sliding block and the phone should not exceed 0.5mm/0.02in. Incorrect adjustment can cause the phone to detach and fall from the mount.
3. When changing to a phone of a different model or size, readjust the positions of the left and right sliding block as well as the top sliding block.
4. Regularly inspect all screws and tighten them promptly if any looseness is observed.
5. Please check the smoothness of the top slider regularly to prevent dust or other foreign matter from accumulating and causing the slider to stall, if any of the above conditions, please clean it in time.
6. When securing the cable of the wireless charging module to the mobile phone mount, ensure that there is enough allowance for rotation. During rotation, ensure that the mobile phone mount does not interfere with other motorcycle components. Due to the presence of the wireless charging module cable on the mobile phone mount, rotating the mount in the same direction for more than 1 full turn is strictly prohibited.
7. To ensure optimal wireless charging performance, when placing the phone, please ensure that the back of the phone is as close as possible to the mobile phone mount. It is recommended to

- use thin phone cases. The farther the phone's back is from the wireless charging module, the lower the charging efficiency will be, with a maximum distance of approximately 3mm/0.12in.
8. Do not use phone cases with metal components on the back, as this can trigger the foreign object detection protection function of the wireless charging module, causing charging to stop.
  9. When installing the mobile phone mount's cable, route the wiring to avoid the vehicle's ignition coil and high-voltage package to prevent electromagnetic interference that might result in abnormal wireless charging operation.
  10. Smartphones come with intelligent temperature control systems. When the external environment temperature is high, there is direct sunlight, poor phone heat dissipation, or excessive charging power causing the phone's temperature to rise, the wireless charging may automatically reduce its power output. This is particularly noticeable with Apple phones, where the temperature control threshold is relatively low. High temperatures may lead to slower charging rates or even charging while discharging. Normal charging will resume once the phone's temperature decreases. For rapid charging, please use the wired charging feature of the mobile phone mount.
  11. Mobile phone mounts with charging capabilities are only suitable for installation on fuel motorcycles with a DC voltage of 12-16V. Do not use beyond this range.
  12. When not using wired charging, please keep the charging port's silicone plug in the closed state.

## After-sales service terms

1. **1-Year Free Warranty Period:** This motorcycle mobile phone mount is eligible for a 1-year free warranty period starting from the date of purchase. In the case of quality issues arising under normal usage conditions within this period, you are entitled to free repair services.
2. **Limited Warranty:** After the 1-year warranty period expires, LOBOO will offer paid repair services. Charges will be based on the actual material replacement costs, and no additional labor costs will be incurred.
3. **Vibration Damping Structure:** This motorcycle mobile phone mount features a multi-damping structure designed to mitigate substantial and high-frequency vibrations. However, it cannot entirely eliminate vibrations. LOBOO and its authorized dealers are not responsible for phone damage caused by vibrations.
4. LOBOO and distributors are not responsible for any damage caused by the fall of the phone due to overuse or failure to follow the instruction.

### **Free warranty services do not cover the following:**

- Faults resulting from improper use, intentional damage, self-disassembly, self-modification, self-repair, or damage to provided cables, or faults caused by operating in unsuitable environments.
- Purchases from unauthorized channels or without valid purchase receipts.

**Please read the related after-sales service terms thoroughly before unpacking and installing the product. By removing the packaging and installing the product, you are indicating your acceptance of these after-sales service terms.**